

Fast Search Controllers for Efficiency Maximization of Induction Motor Drives Based on DC Link Power Measurement

Chandan Chakraborty, Minh C. Ta, Toshiyuki Uchida and Yoichi Hori

Department of Electrical Engineering,
University of Tokyo,
7-3-1 Hongo, Bunkyo, Tokyo, 113-8656, Japan
Phone: +81-3-5841-6678
Fax: +81-3-5841-8573
Email: {chandan}{tacao}{uchida}{hori}@hori.t.u-tokyo.ac.jp

Abstract

This paper presents three new techniques for the efficiency optimization of Vector Controlled Induction Motor Drives. The flux producing current is controlled till the power at the DC Link is minimum. Of the three techniques, the first method is based on the power-flux gradient and the second method reduces the flux producing current in a smooth manner till the DC link power shows an upward trend. The third technique combines Loss Model and Search approaches in a unique manner to propose a hybrid method, where the first estimate is from Loss Model approach and the subsequent adjustment of the flux is through the Search technique. All the three methods are faster than the available methods. Also smooth control of the flux offers excellent dynamic performance. A comparative assessment shows that the hybrid method is the best, even if only a rough estimation of the Induction Motor parameters is available. The close agreement between the simulation and the experimental results confirms the validity and usefulness of the proposed techniques.

Key words: Efficiency Optimization, Search Controller, Loss Model Controller, Hybrid Method, Gradient Technique, Indirect Vector Control, Induction Motor Drive, Electric Vehicles.

1 Introduction

Owing to the advantages of robustness, low cost, small size and requirement of least maintenance, Induction Motors (IMs) are widely used in Industry. The difficulty in control of such machines, particularly in the case of variable speed operation, has been removed by the introduction of better control techniques. Now, using vector control methods, an IM may easily be controlled in the synchronously rotating reference frame just like a separately excited DC machine. However, IM still suffers from the problem of low efficiency, particularly at low load. This is one of the reasons why Permanent Magnet (PM) machines are gaining popularity, where an AC Motor is to be operated at a wide variation of load and increased efficiency is one of the requirements. PM machines are although attractive from the point of view

of high efficiency, however field-weakening to increase the range of speed is not easy. Also recycling the permanent magnets is again a problem. Thus, an energy efficient IM drive may solve much of the problems and investigation in this direction is required.

On the other hand, in applications like Electric Vehicle (EV), energy has to be consumed in the best possible way to increase the running distance per battery charge. Use of IM in such applications also requires an energy optimized control strategy.

2 Loss Model Controller vs. Search Controller

Investigations on efficiency maximization techniques [1-13] may be broadly divided into two categories viz. (i) Loss Model Controller (LMC) based approach [5,8,11,13] and (ii) Search Controller (SC) based technique [1-4,6,7,9,10,12]. Both the methods minimized the motor losses but in different ways. The Loss Model Controller is a feed-forward approach, which calculates the optimum set of variables of the machine, depending on the optimization (maximize or minimize) of an objective function, defined using the machine parameters. The objective function is usually an analytical expression representing either the loss or the efficiency or the total power input. The optimum variable may be the operating flux of the machine or the slip frequency or some other variables depending on the objective function. The fast calculation for the determination of the optimum variables is the merit of this method. However, the demerits are (i) the method is dependent on machine parameters, hence if the approach is not based on on-line estimation of the parameters then it is likely that the method may offer only sub-optimal solution if the parameters of the machine change, (ii) the stray load loss and the mechanical loss also are not strictly constant and an exact modeling of this losses is very complicated, (iii) inclusion of the whole drive system including the power electronic interface requires modeling of the same, which again makes the method more complicated. The Search technique on the other hand depends on the exact measurement of the input power and minimization of the same through a suitable approach. Thus the method does not have the problems of the LMC as outlined.

So far different approaches of the search control

technique for both scalar and vector controlled IM drives have been presented in the literature. However, these publications are still incapable to offer a simple and sufficiently fast algorithm for optimizing system efficiency with better dynamic performance. Therefore, the present paper deals with such problems and presents three simple but very effective algorithms as reported in the following sections.

3 System Layout

The controller for efficiency optimization may be developed for Scalar or Vector controlled IM Drives. For the present study an efficient system with high dynamic performance is the motivation. Therefore the efficiency optimization is carried out for an Indirect Vector controlled IM drives. Usually in the Vector Control drives the operating flux is set at the rated magnitude to have better dynamic performance. For the preset system the flux is decided through an efficiency optimization algorithm. Control of flux offers direct control on the magnetic losses in the machine. When magnetic losses change the corresponding electric losses also vary. Loss minimization is achieved when an optimum balance between the magnetic and electric losses are reached. In the proposed control technique, the magnetic loading is adjusted depending on the trend of the DC link power. In the indirect vector control system, instead of directly manipulating the flux, the flux producing current (i.e. the d-axis current) is controlled. To ensure better dynamic performance as well as efficiency optimization, the efficiency optimization algorithm is put into operation only in the steady state condition. When a transient is detected, the flux is brought back to the rated magnitude and the normal vector control is executed. Operation at

speeds higher than the rated demands field-weakening and may easily be incorporated in the algorithm. Fig.1 shows the configuration of the proposed system.

4 Proposed Techniques

Losses in the IM may be broadly divided into two types viz. variable losses and fixed losses. The copper loss and iron loss depend respectively on the electric and magnetic loading and these losses are controllable. Where as, the fixed losses include stray load losses and the mechanical losses. Therefore an optimum distribution of the copper and core loss offer maximum efficiency.

Now, a set of variables is to be selected, optimization of which would maximize the efficiency of the IM. All of the schemes presented in this paper are for Indirect Vector Controlled IM Drives. In all the schemes, the d-axis current in the synchronously rotating reference frame is considered to be the control variable.

Three new methods for the Search control have been presented here. The methods are (i) Gradient Search Technique, (ii) Ramp Search Technique and (iii) Hybrid Technique. The methods are briefly discussed below.

4.1 Gradient Search Technique

It is well known that for IMs of all sizes, the power vs. flux characteristic is convex by nature. A detailed discussion on such characteristics is available in Ref.11. So far most of the search techniques do not take into consideration of such unique nature of the variation of the losses with the change of operating flux. Most of the available literature is only based on the fact that an optimum flux exists usually below the rated flux value. The typical convex characteristics with no local minima

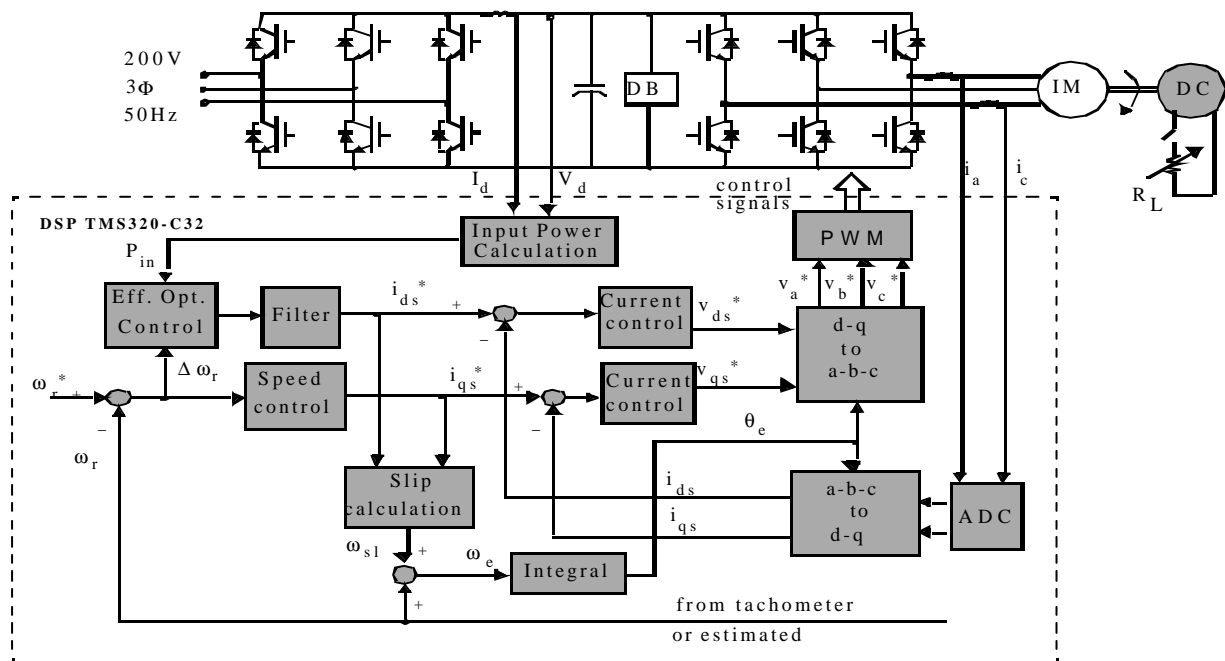

Fig.1. System configuration.

indicate that a gradient-based technique would be more useful to converge to the optimum point.

The Gradient method controls the flux or the flux producing current to first detect the convex region where the optimum point is available and then converges exponentially utilizing the subsequent gradients. The convex region is the region where the subsequent slopes (or gradients) change sign. Initially I_{dsref} (i.e. the reference magnitude of the d-axis current in the synchronously rotating reference frame) is decremented in steps (with step size= Δ). Δ is to be set depending on the loading of the machine. If the load is low Δ may be large and vice versa.

With reference to Fig.2, once the convex is detected the following gradients will be of opposite sign.

$$\text{Slope 21} = (P_2 - P_1)/(i_2 - i_1) \dots\dots\dots (1)$$

$$\text{Slope 32} = (P_3 - P_2)/(i_3 - i_2) \dots\dots\dots (2)$$

Rather than following any of the standard optimization techniques, the method developed here considers the actual work environments, where noise and higher harmonics in current and ripples in DC Link are always present. Efforts are also put to achieve fast convergence and to make the method simple and easy to implement. To avoid any possible mal-operation due to the noise and ripples in DC link power, the reference d-axis current is used instead of the actual and the DC link power is filtered. The time step is set sufficiently large to include the time delay due to the filtering of the DC link power. The following steps may be chalked out for the algorithm:

Step-1: Starting from the rated magnitude, the flux producing current is reduced in steps and the slopes **Slope21** and **Slope32** are calculated using (1) and (2) until these two slopes are opposite in sign,

Step-2: A new current i_4 is calculated as:

$$i_4 = i_3 + 0.5(i_2 - i_3) \dots\dots\dots (3)$$

Step-3: A new slope is calculated using,

$$\text{Slope 42} = (P_4 - P_2)/(i_4 - i_2) \dots\dots\dots (4)$$

The sign of **Slope 32** and **Slope 42** are tested. If they are opposite then Step-4 is executed else Step-5 is executed.

Step-4: The points {2,4,3} in Fig.2 are replaced by {1,2,3} and then new values of Slope21 and Slope32 are calculated. Step-2 is executed next.

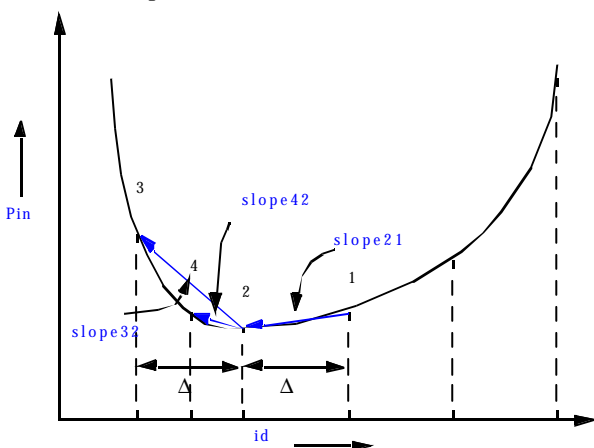

Fig.2. Different slopes of the Gradient method.

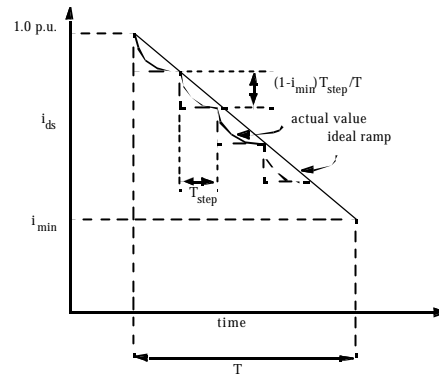

Fig.3. Reduction of control variable in Ramp method.

Step-5: The points {1,2,4} are replaced by {1,4,3} and a new point i_2 is calculated using:

$$i_2 = i_1 - 0.5(i_1 - i_4) \dots\dots\dots (5)$$

The power P_2 corresponding to current i_2 is sensed and new values of **Slope 21** and **Slope 32** are calculated. Step-3 is executed next.

Iterations continue until convergence is achieved. The test for the convergence may be checked in Step-3. A test may be designed based on how close **Slope 21** and **Slope 32** are, or how close two currents i_1 and i_3 are.

4.2 Ramp Search Technique

In this method of control, the flux or flux producing current is again considered as the control variable. Now, in the search control, the control variable is to be changed according to the information of the power input. If flux is changed in steps then torque pulsations occur, which is undesirable. This has called for additional compensation scheme [7] to keep the torque fluctuation within limit. Furthermore, many of the search techniques reported so far contain the risk of too much reduction in flux giving rise to stability problem. Usually, this is checked by putting a minimum limit of the flux. But the problem remains is that, reaching of the minimum limit during the process of search, may cause early termination of the search routine, if not properly taken care. To avoid such problems, in the proposed method a gradual (ideally ramp) reduction of the control variable is enforced.

Therefore, the flux or flux producing current is decreased and corresponding power input is measured. Decrement of the control variable is continued until the input power shows an upward trend. When subsequent magnitude of the power input is higher, the search is stopped and the control variable is restored to the earlier step value and the optimum condition is thus reached. Thus in the proposed scheme the control variable is decreased in smallest permissible steps, the magnitude of steps following the corresponding ramp. Considering the flux producing current to be the control variable, the algorithm starts with the 1 p.u. value and proceeds with small steps towards a preset minimum (i_{min}) in a total time of T (say) sec. Thus the slope of the ramp is $(1-i_{min})/T$. If the step time be assumed as T_{step} , then in

each of the iterations the current reduction is $(1-i_{\min})T_{\text{step}}/T$. To avoid the problems of torque fluctuations the reference current from the EOC controller is fed through a 2nd order filter with matched response. Thus with the use of the filter a smooth reduction in flux-current is possible instead of the step, as explained in Fig.3.

Many of the available methods require an estimate of the minimum magnitude of the flux producing current (i_{\min}), which is not always easy. A proper selection of i_{\min} and step size has a profound impact on the speed of the convergence. This makes many of the available methods more complicated. The gradient method described earlier does not use any estimate of the i_{\min} in the search process. However, convergence speed depends on the selection of the step size. The ramp method seems fairly independent of both the i_{\min} and step size if a sufficiently small step size is selected. This is a great advantage of this method. Although, in Fig.3 and in earlier discussion i_{\min} is used to explain this method, it is quite simple to understand that the method works fine if reduction in the current is exercised in constant steps keeping $\Delta i/\Delta T$ constant and feeding the same through a filter as discussed earlier.

The decision of convergence is taken by inspecting the successive magnitudes of the DC link power measured. The DC link power always contains ripples and noise, which must be filtered out properly to ensure that convergence is achieved to the optimum magnitude. As IM is essentially a higher order system therefore the power output corresponding to change in flux producing current follows the nature of higher order system response. Therefore the DC link power should be allowed to settle down to the steady value after each of the step-change of the flux producing current. On the other hand, in this method the optimum magnitude of the flux producing current is considered integral number of steps away from the initial (usually the rated) value. So a large step size may not converge to the real optimal condition. All these indicate that a proper selection of step size is essential for better response of this method.

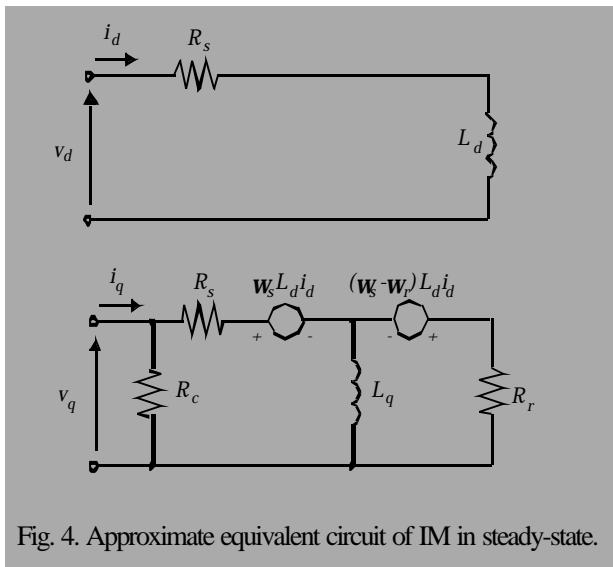

Fig. 4. Approximate equivalent circuit of IM in steady-state.

4.3 Hybrid Technique

As explained earlier, the Loss Model Controller offers the best performance in terms of the fastness in operation. However, this involves an exact modeling of the non-linear losses, which is very complicated and also requires a great deal of computation. Furthermore, parameter like rotor resistance depends also on the machine temperature and undergoes considerable variation during the time of operation of the Drive systems. All these problems may be avoided and still a fairly fast convergence may be achieved if a hybrid technique is evolved utilizing the goodness of both the Loss Model and the Search Technique as explained here.

The hybrid method uniquely combines Loss Model and Search Control Techniques. To expedite the search process all of the Search Controllers face the problems viz. (i) to decide the step size of the control variable depending on the load and also (ii) to set the minimum and maximum limit of the control variable. These are very important tasks and usually require some operating experience on the drive set. However, this can be avoided or managed by introducing the Loss Model Controller to find the initial estimate of the $I_{d\text{ref}}$ and the subsequent adaptation to reach and always stay in optimum may be had by the Ramp Search Technique as proposed earlier.

The approximate equivalent circuit in Fig.4 is used to calculate the first estimate in the hybrid method. Standard notations of the parameters are used and R_c is the equivalent resistance that represents the core loss. The condition for loss minimization may be derived as [6,13]:

$$I_{d\text{ref}} = \sqrt{\frac{(R_s + R_r)R_c}{R_s\{(R_s + R_r) + R_c\} + L_d^2 w_f^2}} I_{qs} \dots\dots\dots (6)$$

5 Simulations

The system has been simulated using MATLAB/SIMULINK. A digital model of the IM has been developed. Core loss is accounted simply by adding a loss proportional to the square of the applied stator voltage of the IM. An estimated core loss resistance, which varies with the machine saturation, has been used. The power electronic interface is considered to be ideal. The flux producing current is controlled instead of the flux as explained earlier. Simulations have been carried out for the identical conditions for all the three cases. A load torque of 1.5 Nm is applied. The motor is accelerated to the step speed command of 0.5 p.u. from start. At around 3.8 sec. the efficiency optimization techniques are initiated. Fig.5 to 7 show the simulation results for the Gradient, Ramp and Hybrid methods respectively. The figures show speed, reference d-axis current ($I_{d\text{ref}}$), actual d-axis current (I_{ds}), actual q-axis current (I_{qs}), developed torque (T_e), Rotor Flux and power input (P_{in}) from top to bottom order. All the approaches show fast convergence to the minimum

power input. The Gradient and the Hybrid methods require less than 1 sec. to converge. The Ramp on the other hand takes a little more than 2 secs. The dynamic performance is best for the Ramp owing to the smooth change of the flux. It is easy to recognize that the Hybrid method offers both fastness and high dynamic performance. In all of the cases power input reduces from 134 W to about 105 W. Thus a reduction of 21.6% power input is possible.

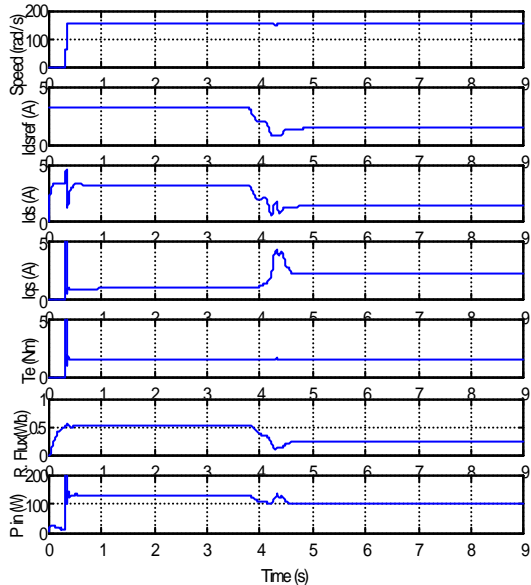

Fig.5. Simulation results for Gradient method.

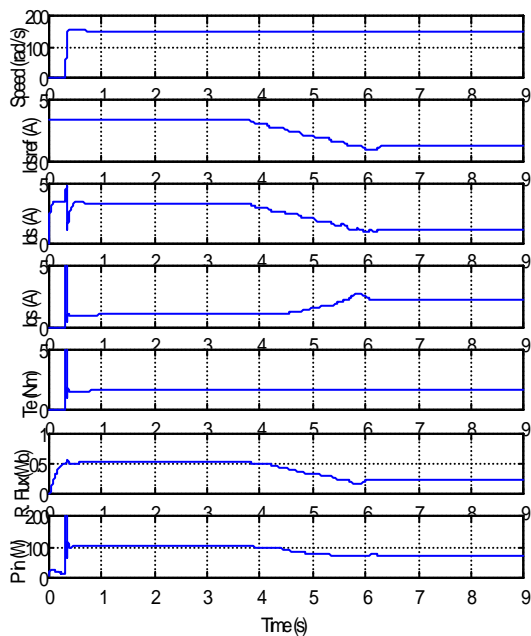

Fig.6. Simulation results for Ramp method.

6 Experimental Results

All the three techniques for the efficiency optimization have been realized and tested in the laboratory. A laboratory set-up is fabricated for such purpose. The

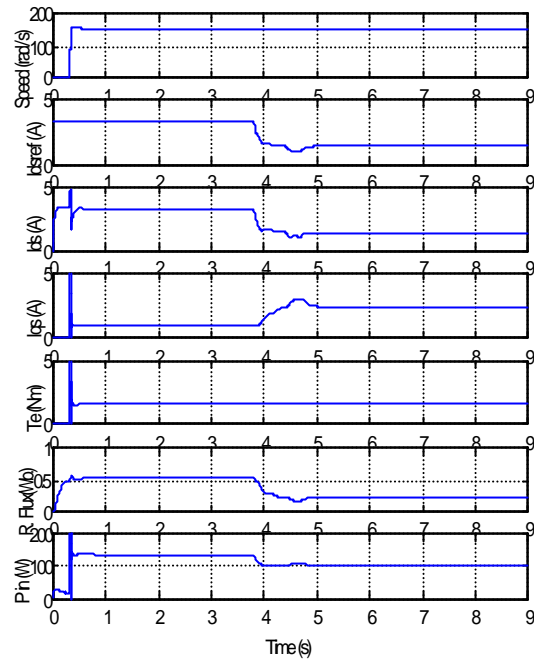

Fig.7. Simulation results for Hybrid method.

Induction motor is connected to the mains through a power electronic interface consisting of rectifier-filter-inverter. In Fig.1 the left inverter is operated as a rectifier. A 2.2kW IM is used which is coupled to a DC Machine. The parameters of the IM are shown in the Appendix. The DC machine operates as a generator to act as an adjustable load to the IM. The efficiency optimization algorithm including the Vector Control part is written in C language and implemented on a single DSP (TMS320-C32).

Initially to confirm the validity of the proposed techniques and the results of the simulation, experiments are conducted for identical condition as reported in the simulation. Fig.8 to 10 show the experimental results respectively for the Gradient, Ramp and Hybrid methods. All the results are in close agreement to the simulation results reported in Fig.5 to 7. Excellent convergence has been achieved in all the three cases. A reduction of 30W (from 138W at rated flux to about 108 W at optimal flux) has been noticed. Thus a saving of about 21.7% of input power is assured. This shows that the proposed methods are very suitable for the efficiency optimization of the IM Drive. A comparative assessment of the methods has been presented in the following section.

Finally, Fig.11 shows a complete development of the efficiency optimization routine taking into account the possibility of a change in the loading condition. A step change in speed (from 0.5 p.u. to 1.0 p.u.) is considered when the Hybrid method is in operation. When the change in speed is sensed, the flux is immediately reset to the rated magnitude and the Hybrid method is activated again when steady state is reached. Also once in steady state, the Hybrid algorithm remains always in operation to account for a possible change in motor parameters or a slow change in working environments.

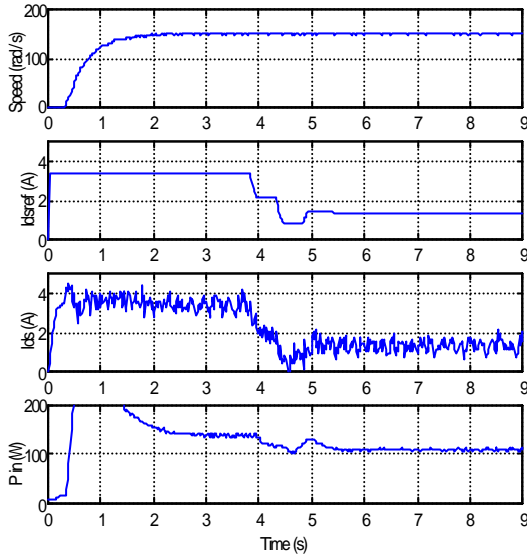

Fig.8. Experimental results with the Gradient method.

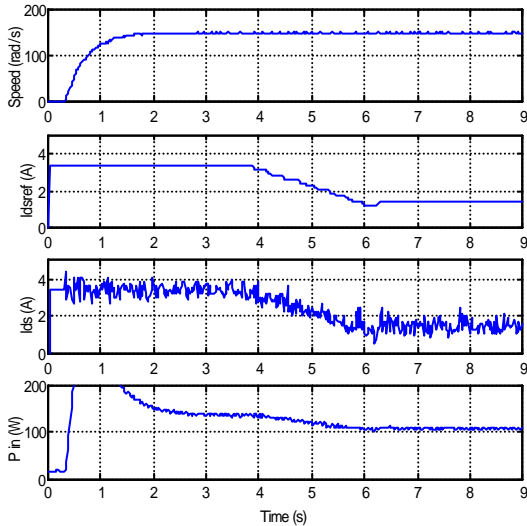

Fig.9. Experimental results with the Ramp method.

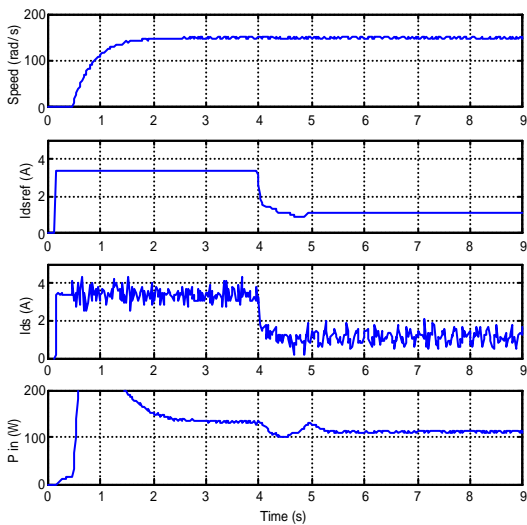

Fig.10. Experimental results with the Hybrid method.

7 Discussion of the Methods

The results from the simulation and experiments show that all the three methods are equally capable to converge to the optimum efficiency. Also the proposed methods are faster than that are available in the existing literatures. The fastness of the Gradient method depends on the step size and also on the Power-Flux characteristics of the particular machine at the particular load and speed. Sometimes the gradient can be very low which may cause a delay in the speed of convergence. However, a proper step-size can avoid this problem. Moreover when the gradient is low then greater reduction of flux only produces relatively small change in efficiency. This situation may be utilized to decide for a compromise between better-efficiency and better-dynamic-performance, because operation at higher magnitude of flux offers better transient behavior in case of a possible load change. Speed of convergence depends also on the step size and selection of a proper step size depending on the operating condition (i.e. load, speed and etc.) was never easy. All these problems make the gradient technique and almost all of the available techniques either complicated with higher speed of convergence or simple with delayed response.

The Ramp method on the other hand can work without the need of setting a minimum limit of the flux. This is also the simplest one and offers better dynamic behavior during the search process. This is because the step size is very small. However, this method requires adequate filtering of the input power. The technique may not reach to the optimum due to the higher noise or ripples in the measured DC link power. This may be overcome by always keeping the flux variations in operation.

The Search technique does not require the information of the parameters and can adapt to the change in operating conditions. However, even if a rough estimate of the parameters is available, the Hybrid method offers the best performance. This method offers the fastness of the Loss Model Controller and parameter independence feature of the Search Controller.

8 Conclusions

Three novel efficiency optimization controllers for the Induction Motor have been presented in this paper. The techniques are for Indirect Vector Controlled Induction Motor Drive, where an outer loop has been added to decide the flux. The flux is controlled depending on the trend of the DC Link power. Of the three methods, the gradient and the ramp approaches follow pure search techniques. The 3rd method combines both, the loss model and the search methods in a unique manner to extract the best of both. Thus, the hybrid method possesses fastness as well as the capability of adaptation for a possible change in loading conditions or a variation in motor parameters. Excellent dynamic performance has been confirmed by feeding the control variable through a filter. This ensures smooth change of the flux producing current resulting excellent torque response. All of the

proposed methods are validated by simulation and prototype experiments. A comparative assessment is also presented, which shows that the Hybrid method offers the best overall performance. Such control schemes are very suitable for Electric Vehicles and other applications, where high dynamic performance as well as efficiency optimization have competitive edge and therefore highly desirable.

Appendix

Induction machine rating:

200V three-phase, 50Hz, 2.2 kW, four-pole, 1430 r/min.

Motor Parameters:

$R_s = 0.877\Omega$, $R_r = 1.47\Omega$, $R_C = 102\Omega$, $L_s = L_r = 165.142$ mH, $L_m = 160.8$ mH.

The rotor inertia J of the I.M. is 0.015 kg.m².

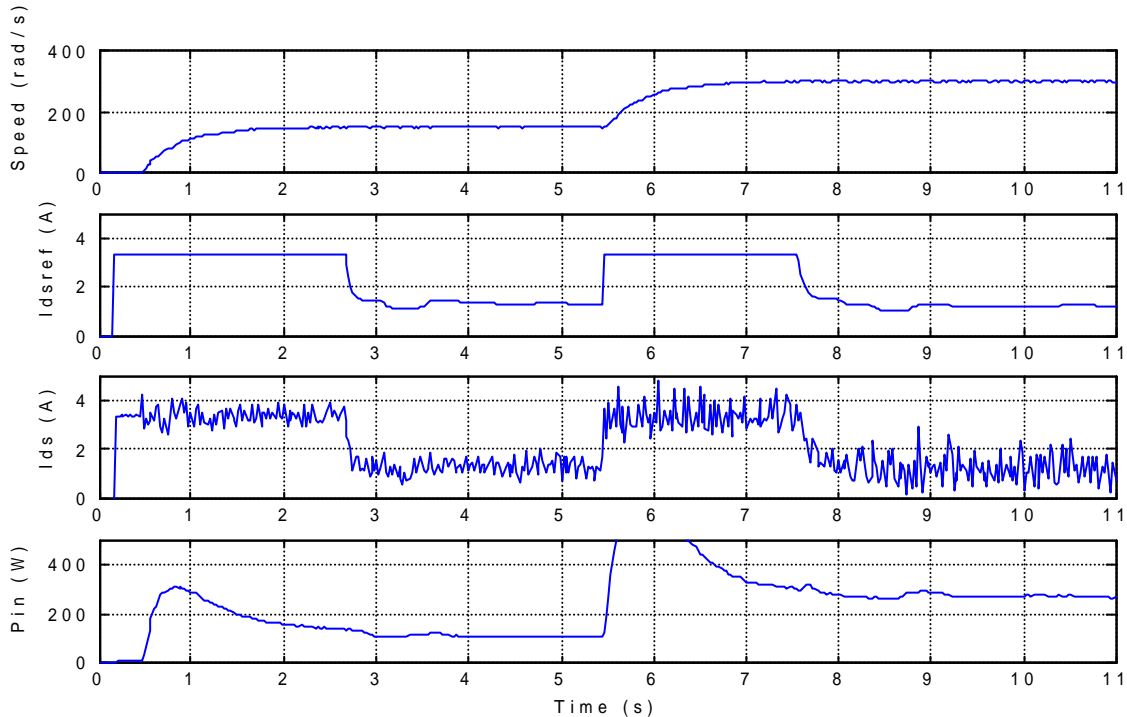

Fig.11. Dynamic test with a change in speed reference for the Hybrid technique.

References

1. D. S. Kirschen, D. W. Novotny, and W. Suwanwisoot, "Minimizing Induction Motor Losses by Excitation Control in Variable Frequency Drives," *IEEE Trans. Ind. Appl.*, Vol.20, No.5, pp.1244-1250, 1984.
2. D. S. Kirschen, D. W. Novotny, and T. A. Lipo, "On-line efficiency optimization of a variable frequency induction motor drive," *IEEE Trans. Ind. Appl.*, Vol.21, No.4, pp.610-615, 1985.
3. S. K. Sul, and M. H. Park, "A novel technique for optimal efficiency control of a current-source inverter-fed induction motor," *IEEE Trans. Power Electron.*, Vol.3, No.2, pp.192-199, 1988.
4. J. C. Moreira, T. A. Lipo, and V. Blasko, "Simple efficiency maximizer for an adjustable frequency induction motor drive," *IEEE Trans. Ind. Appl.*, Vol.27, No.5, pp.940-946, 1991.
5. R. D. Lorenz, and S. M. Yang, "Efficiency-optimized flux trajectories for closed-cycle operation of field-orientation induction machine drives," *IEEE Trans. Ind. Appl.*, Vol.28, No.3, pp.574-580, 1992.
6. G. O. Garcia, J. C. Mendes Luis, R. M. Stephan, and E. H. Watanabe, "An efficient controller for an adjustable speed induction motor drive," *IEEE Trans. Ind. Electron.*, Vol.41, No.5, pp.533-539, 1994.
7. G. C. D. Sousa, B. K. Bose, and J. G. Cleland, "A fuzzy logic based on-line efficiency optimization control of an indirect vector-controlled induction motor drive," *IEEE Trans. Ind. Electron.*, Vol.42, No.2, pp.192-198, 1995.
8. I. Kioskeridis, and N. Margaris, "Loss minimization in induction motor adjustable speed drives" *IEEE Trans. Ind. Electron.*, Vol.43, No.1, pp.226-231, 1996.
9. J. S. Hsu, J. D. Kueck, M. Olszewski, D. A. Casada, P. J. Otaduy and L. N. Tolbert, "Comparison of Induction Motor Field Efficiency Evaluation Methods," *IEEE Trans. Ind. Appl.*, Vol.34, No.1, pp.117-125, 1998.
10. G. K. Kim, I. J. Ha, and M. S. Ko, "Control of induction motors for both high dynamic performance and high power efficiency," *IEEE Trans. Ind. Electron.*, Vol.39, No.4, pp.323-333, 1992.
11. F. Abrahamsen, F. Blaabjerg, J. K. Pedersen, and P. B. Thogersen, "Efficiency optimized control of medium-size induction motor drives," *IEEE IAS Conf. Rec.*, 2000, Rome.
12. M. Ta-Cao, and Y. Hori, "Convergence improvement of efficiency-optimized control of induction motor drives," *IEEE IAS Conf. Rec.*, 2000, Rome.
13. F. Fernandez-Bernal, A. Garcia-Cerrada and R. Faure, "Model-based loss minimization for DC and AC vector-controlled motors including core saturation," *IEEE Trans. Ind. Appl.*, Vol.36, No.3, pp.755-763, 2000.