

Experimental Study on EV's Lateral Motion Stabilization with Fast Feedback Control of 4 In-wheel Motors

Shin-ichiro SAKAI*
The Institute of Space and
Astronautical Science

Satoshi HARA
Japan Broadcasting
Corporation

Yoichi HORI
The University of Tokyo

*3-1-1, Yoshinodai, Sagami-hara, Kanagawa, Japan
Tel: +81-42-759-8308 / Fax: +81-42-759-8473
E-mail : sakai@pub.isas.ac.jp
URL: www.hori.t.u-tokyo.ac.jp/997/sakai

Abstract

Electric motors in Electric Vehicles (EVs) has quite fast torque response, thus fast minor feedback loops can be applied for vehicle motion stabilization. This paper clarified that such feedback loop can stabilize the dynamics of driven wheel on the slippery road surface. With such loop, driven wheel has large inertia equivalently. It can stabilize the vehicle's lateral dynamics, if minor feedback loops are independently installed in the driven wheels. This effect was demonstrated with simulations and experiments. It suggests the effectiveness of minor feedback loops in the total control system like *DYC* (Direct Yaw Moment Control). This paper also introduces our novel 4-motored EV "UOT Electric March II", which is newly constructed for these experiments.

Keyword: Electric vehicles, Motion control, Mechatronics, Traction, Control.

1 Introduction

Recently, electric vehicles (EVs) are intensively developed. With improvement of motors and batteries, some pure EVs (PEVs) with only secondary batteries have already achieved enough performance. Hybrid EVs (HEVs), like Toyota Prius, are going up to the commercial products. Fuel cell EVs (FCEVs) will possibly be major vehicles in this 21st century. The background of this developments is energy and environmental problems, thus main concern over EVs is energy efficiency and environmental impacts. However, another important advantage exists, which is not recognized well yet. It is controllat

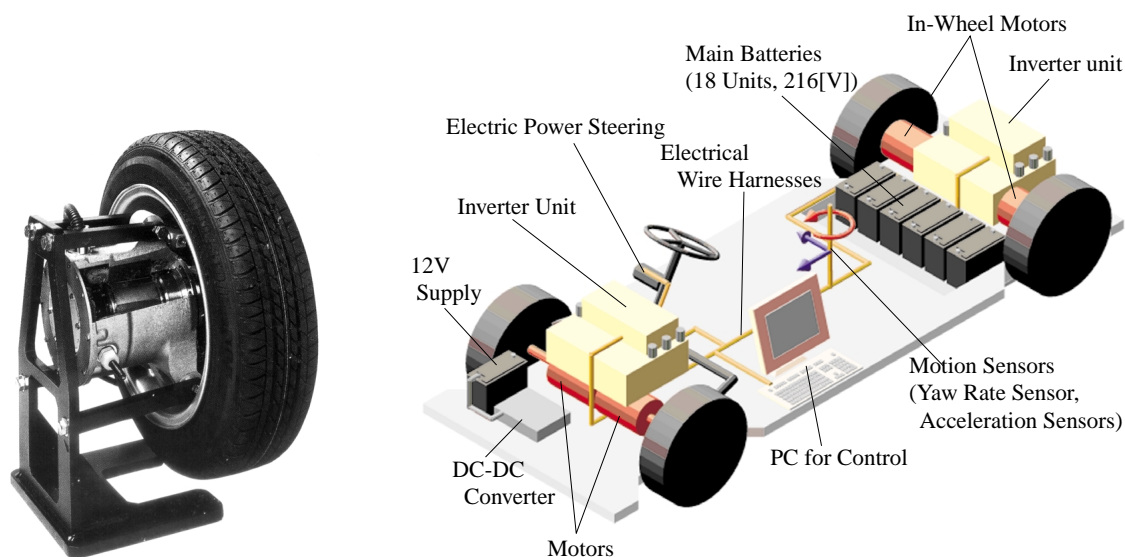

Fig. 1: In-wheel motor (left) and our new EV with four in-wheel motors. (right)

From the viewpoint of electrical and control engineering, EVs have evident advantages over internal combustion engine vehicles (ICVs). These advantages can be summarized as:

1. ***Torque generation of electric motor is very quick and accurate, for both accelerating and decelerating.***

This should be the essential advantage. ABS (antilock brake system) and TCS (traction control system) should be integrated into “total TCS”, since a motor can both accelerate or decelerate the wheel. Its performance should be advanced one, if we can fully utilize the fast torque response of motor [1].

2. ***Motor torque is easily comprehensible.***

There exists little uncertainty in driving or braking torque inputted by motor, compared to that of combustion engine or hydraulic brake. Therefore, simple “driving force observer” can achieve a real-time observation of driving/braking force between the tire and road surface [2] [3]. This second advantage will contribute a great deal to several applications like road condition estimation.

3. ***Motor can be attached to each wheel.***

With motors like in-wheel motors (Fig. 1), even the anti-directional torque generation is possible on left and right wheels. In automobile engineering, such approach is known as DYC (direct yaw moment control) [4] [5]. Distributed motor will possibly enhance its performance.

Definitely, these indicate the novel approach for vehicle motion control in EVs. Automobile engineers recently assume that active vehicle control is the important technique. It is directly connected with safety, or human life. We, electric engineers, will be able to contribute a lot to this novel and important theme: advanced motion control of EVs.

In this paper, stabilization of vehicle lateral dynamics is studied based on issue 1 and 3. If several motors are on the EV, fast minor feedback can be applied for each driven wheel. Such feedback controller can change the wheel dynamics and enhance its stability [6]. Then, how does it affect the vehicle lateral stability? This paper shows the basic experimental results on this topics.

Section 2 describes the controller on each wheel, which enhance the wheel’s stability. In section 3, simulation results explain the effect of this method on vehicle lateral stability. “UOT Electric March II” is a novel 4-motored EV, which is constructed for experimental studies (Fig. 1 and 2). Section 4 introduces this laboratory-made EV, then shows the demonstrated effect of proposed method. Section 6 concludes this paper.



Fig. 2: “UOT Electric March II” running at about 100 [km/h].

2 Wheel velocity controller for skid prevention

In this section, the wheel velocity controller for skid prevention is discussed. The starting point of this idea is to utilize the knowledge on motion control, which is based on the motor control. In general, the feedback controller can change the dynamics of plant, or we can re-design the plant dynamics. For example, the plant can be insensitive against disturbance if appropriate feedback controller is applied. Such feedback controller requires fast response of actuator, and it is available in EVs. So, how we should design the controller or plant dynamics for skid prevention? This is the main topics in this section.

2.1 Slip phenomena and linear slip model

Ordinary, slip ratio λ is used to evaluate the “slip”. Slip ratio λ is defined as,

$$\lambda = \begin{cases} \frac{V_w - V}{V_w} & : \text{for accelerating wheel,} \\ \frac{V_w - V}{V} & : \text{for decelerating wheel,} \end{cases} \quad (1)$$

where V is the vehicle chassis velocity. V_w is the velocity equivalent value of wheel velocity, $V_w = r\omega$, where r , ω are the wheel radius and wheel rotating velocity, respectively.

With simple one wheel model (Fig. 3), the motion equations of wheel and chassis can be obtained as

$$M_w \frac{dV_w}{dt} = F_m - F_d(\lambda), \quad (2)$$

$$M \frac{dV}{dt} = F_d(\lambda), \quad (3)$$

if air resistance on chassis and rotating resistance on wheel are both negligible. M and M_w are the vehicle weight and the mass equivalent value of wheel inertia, respectively. F_m is the force equivalent value of accelerating/decelerating torque, generated by engine, hydraulic brake system or motor. F_d is the driving/braking force between the wheel and the road surface. This F_d has nonlinear dependence on the slip ratio λ , such as in Fig. 4¹.

For the controller design process, linear skid model is derived from (1)-(3) and $F_d(\lambda)$ in Fig. 4. Nonlinearity exists in $F_d(\lambda)$ or $\mu - \lambda$ curve, therefore, perturbation equation for $F_d(\lambda)$,

$$\Delta F_d = N \Delta \mu = N a \Delta \lambda \quad (4)$$

$$= a \left(\frac{\partial \lambda}{\partial V} \Delta V + \frac{\partial \lambda}{\partial V_w} \Delta V_w \right) \quad (5)$$

$$= -\frac{1}{V_{w0}} \Delta V + \frac{V_0}{V_{w0}^2} \Delta V_w \quad (6)$$

is used here. The parameter a is the gradient of $\mu - \lambda$ curve,

$$a = \left. \frac{\partial \mu}{\partial \lambda} \right|_{(V_0, V_{w0})}. \quad (7)$$

V_{w0} , V_0 are the wheel velocity and chassis velocity at the operational point, respectively. With (1)-(3) and (6), the transfer function from motor torque F_m to the wheel velocity V_w is

$$P(s) = \frac{\Delta V_w}{\Delta F_m} = \frac{1}{(M_w + M(1 - \lambda_0))s} \frac{\tau_w s + 1}{\tau_a s + 1}, \quad (8)$$

¹ $\mu = F_d/N$, where N is the normal force on the wheel.

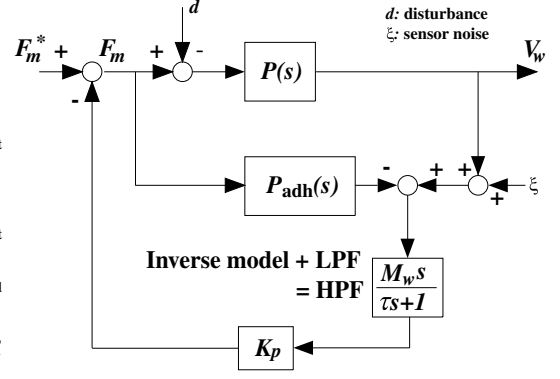
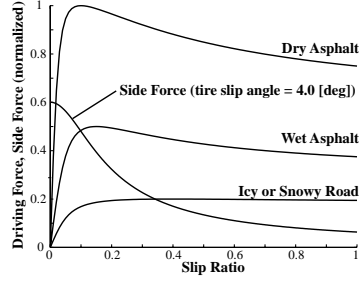
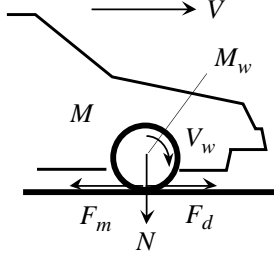

Fig. 3: One wheel model. Fig. 4: Typical $\mu - \lambda$ curve.

Fig. 5: Proposed feedback controller.

where

$$\tau_a = \frac{M_w V_{w0}}{aN} \frac{M}{M(1 - \lambda_0) + M_w}, \quad \tau_w = \frac{M V_{w0}}{aN}. \quad (9)$$

λ_0 is a slip ratio at the same operational point (V_0, V_{w0}).

From (8)-(9), the most simple model for adhesive wheel ($\lambda_0 \ll 1.0$), $P_{adh}(s)$, can be described as

$$P_{adh}(s) = \frac{1}{M + M_w} \frac{1}{s}. \quad (10)$$

On the other hand, for the completely skidding wheel ($\lambda \simeq 1.0$), the dynamics seems to be $P_{skid}(s)$,

$$P_{skid}(s) = \frac{1}{M_w} \frac{1}{s}. \quad (11)$$

2.2 Controller design

One dominant phenomenon in the wheel skidding is the rapid change of wheel rotating velocity. During the acceleration, the wheel velocity rapidly increases with wheel skidding, and during the deceleration it rapidly drops due to the wheel lock. Eq. (10) and (11) describe that sudden drop of wheel equivalent inertia causes this rapid change of wheel velocity. Based on this viewpoint, we design the feedback controller of Fig. 5 [1]. The transfer function from acceleration command F_m^* to wheel velocity V_w with this controller is as follows:

- (1) If wheel is adhesive, i.e., $P(s) = P_{adh}(s)$,

$$\frac{V_w}{F_m^*} = P_{adh}(s). \quad (12)$$

Therefore, the wheel dynamics against the acceleration/deceleration command is same as the original one. Feedback controller does nothing for adhesive wheel.

- (2) If wheel is skidding, i.e., $P(s) = P_{skid}(s)$,

$$\frac{V_w}{F_m^*} = \frac{\tau s + 1}{\tau s + 1 + K_p \frac{M}{M + M_w}} \frac{1}{M_w s}. \quad (13)$$

For the low frequency region $\omega \ll 1/\tau$,

$$\frac{V_w}{F_m^*} = \frac{1}{\frac{(1 + K_p)M + M_w}{M + M_w} M_w s} \quad (14)$$

Eq. (14) shows that the feedback controller modifies the wheel equivalent inertia for skidding wheel. For example, this transfer function comes to be

$$\frac{V_w}{F_m^*} = \frac{1}{(M + M_w)s} = P_{adh}(s), \quad (15)$$

if feedback gain K_p is chosen to be

$$K_p = K_p^* = \frac{M + M_w}{M_w}. \quad (16)$$

Fig. 6 shows the bode diagram of V_w/F_m^* . Upper graph plots V_w/F_m^* for wheel without controller, i.e., plots $P_{adh}(s)$ and $P_{skid}(s)$. If the controller of Fig. 5 is applied with K_p of (16) and $\tau = 0.1[s]$, these transfer functions change into the ones in the lower graph. These figures clearly indicate that the dynamics of skidding wheel comes to be almost same as that of adhesive wheel, the “heavy” wheel. The wheel with proposed controller is insensitive for slip phenomena.

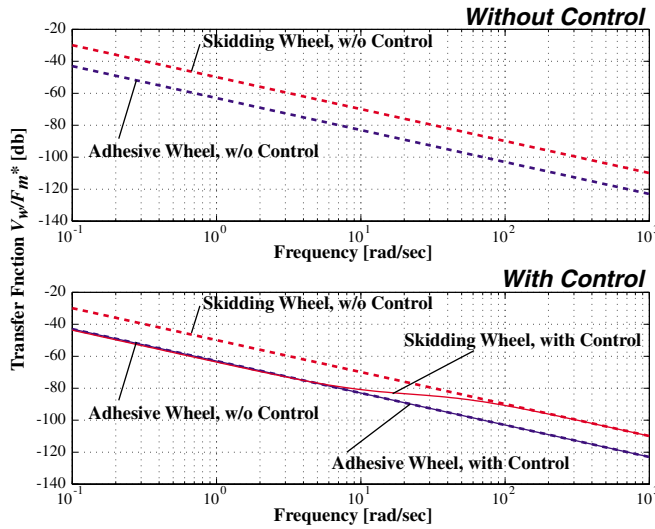

Fig. 6: Bode diagram of V_w/F_m^* .

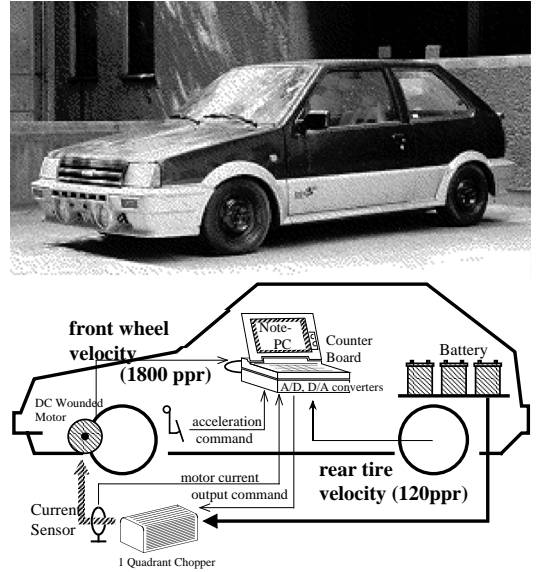

Fig. 7: “UOT Electric March-I”.

2.3 Experimental results

Experiments were carried out to confirm the proposed method. These experiments were carried out with “UOT Electric March-I”, which is our laboratory-made EV (Fig. 7) constructed in 1997 [1]. To examine the effect of wheel velocity control for skid avoidance, slippery low μ road is required. We put the aluminum plates of 14[m] length on the asphalt, and spread water on these plates. The peak μ of this test road is about 0.5. This value was estimated based on some other experimental results [3].

Fig. 8 shows the time responses of slip ratio. In these experiments, vehicle accelerated on the slippery test road, with lineally increasing motor torque. Without control, the slip ratio rapidly increases. On the contrary, the increase of slip ratio is relatively slow with proposed controller. Fig. 9 plots the wheel and chassis speed. It shows the wheel velocity’s insensitivity to the slip status. In other words, the wheel equivalent inertia during the wheel skidding comes to be “heavy” with wheel velocity control, thus the rapid increase of slip ratio can be suppressed.

Note that this method cannot be a complete skid prevention controller by itself. Proposed controller suppressed the rapid growth of slip ratio, however, the slip ratio finally exceeded the

stable limit (Fig. 8). Therefore, we suggest this method as a minor-loop controller, to improve other method like conventional ABS or skid detection technique with EV [7].

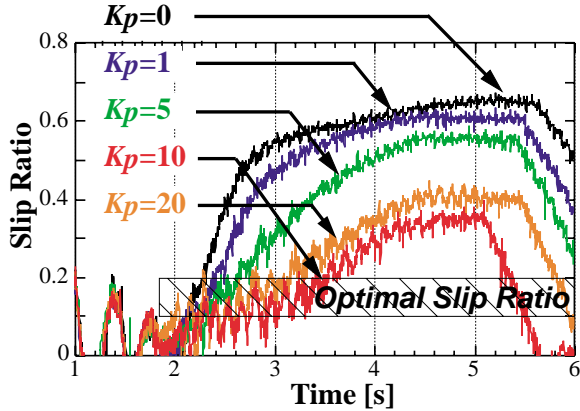

Fig. 8: Effect of wheel velocity control for skid prevention with $\tau=0.1$ [s] (Experimental results.) K_p^* of Eq. (16) is 4.52 for this vehicle.

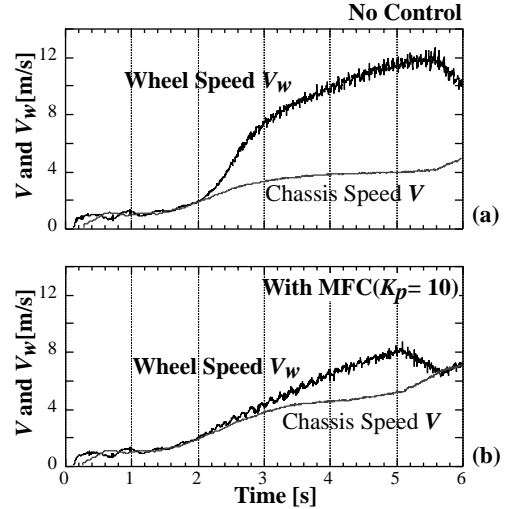

Fig. 9: Proposed controller changes the wheel dynamics to be insensitive to the road condition.

3 Lateral motion stabilization with wheel velocity controller

In the previous section, wheel velocity feedback method was discussed. With this method, wheel equivalently has heavy inertia during slip. This suppresses the rapid increase of slip ratio. Then, what will happen if we apply such feedback loop for every wheel of turning vehicle on slippery road ?

As commonly known, the vehicle lateral motion can be sometimes unstable. This instability occurs in such situation as rapid braking during the turning, especially with slippery road condition with snowy or rainy weather. Here we assume that one small motor is attached on every wheel of target EV. In-wheel motor is a typical example (Fig. 1). With such motors, the wheel velocities can be controlled independently. Our simulation results (Fig. 10) show that this minor loops can enhance the vehicle's lateral stability [6]. Chassis's 3-DOF nonlinear motion, four wheel's rotation and dynamic load distribution are calculated in these simulations.

In these simulations, the vehicle starts running on the slippery road ($\mu_{\text{peak}} = 0.5$), turning left with steering angle $\delta_f = 3$ [deg]. Then at 5.0 [sec], the driver inputs rapid braking torque $F_m = -1100$ [N] on each wheel. This torque exceeds the tire performance. Therefore, the wheel skid occurs and the chassis starts the spin motion, although the driver stops braking at 9.0 [s]. This wheel skidding is serious at rear-left wheel especially, since the center-of-gravity is shifted and the load distribution varied.

On the contrary, if the wheel velocity controller is applied independently for each wheel, such dangerous spin motion is prevented. The rear-left wheel's torque is most reduced automatically. Note that this method uses only wheel velocities as feedback signals, therefore, differs considerably from conventional methods like DYC [4] [8]. The autonomous stabilization of each wheel, which is achieved with wheel velocity feedback, enhances the stability of vehicle lateral motion on slippery road. This effect is demonstrated in the next section.

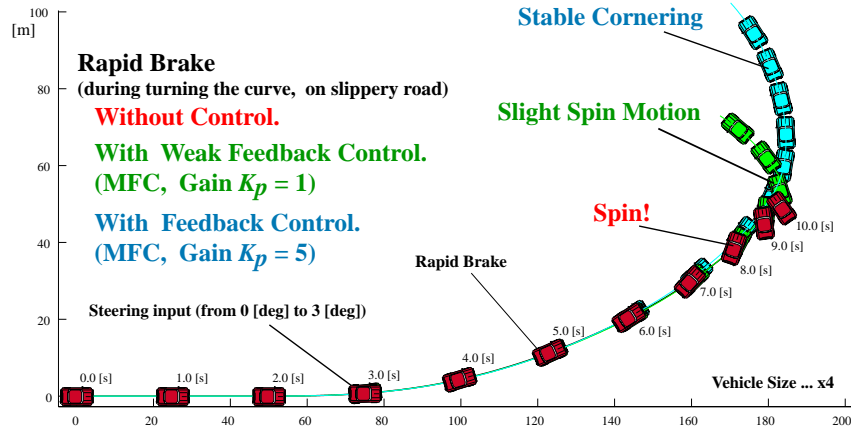

Fig. 10: Stabilizing effect with “controlled four wheels” is visualized with vehicle’s trajectory [6].

4 Basic Experimental Results with “UOT Electric March II”.

4.1 Novel Experimental EV “UOT Electric March II”

“UOT Electric March II” is our novel EV for experimental discussions. This EV can be characterized by its original motor configuration: 4 independent motors. Each wheel has their own driving motor, therefore, driven wheels can be independently controlled. Regenerative braking is also available in this vehicle. We ourselves designed and built up this vehicle, based on the conventional ICV “Nissan March”.

The specification of this EV focuses on the motion control experiments. It has adequate devices for experiments: on-board PCs and several sensors like fiber-optic gyro. Motion controller constructed in the PC outputs the torque commands, and inverter units generate the torques of these values. This precise torque generation is achieved by motor current controller in the inverter unit. On the other hand, the distance for one-charge, energy efficiency, driving comfort or other features are excluded from discussions. Table 1 summarizes the key specifications of “UOT Electric March II”.

Table 1: Specifications of “UOT Electric March II”.

Drivetrain	4 PM Motors
Max. Power(20 sec.)	36 [kW] (48.3[HP])*
Max. Torque	77* [Nm]
Gear Ratio	5.0
Battery	Lead Acid
Weight	14.0 [kg](for 1 unit)
Total Voltage	228 [V] (with 19 units)
Base Chassis	Nissan March K11
Wheel Base	2360 [m]
Wheel Tread F/R	1365/1325 [m]
Total Weight	1400 [kg]
Wheel Inertia**	8.2 [kg]***
Wheel Radius	0.28 [m]
Controller	
CPU	MMX Pentium 233[MHz]
Rotary Encoder	3600 [ppr]***
Gyro Sensor	Fiber Optical Type

* ... for only one motor.

** ... mass equivalent.

*** ... affected by gear ratio.



Fig. 11: Photo of turning experiments with 4W-motored EV “UOT Electric March II” (Fig. 12-13).

4.2 Basic Results of Lateral Motion Stability with Motor Feedback Control

Then the results of first experiments using “UOT Electric March II” is discussed here. In these experiments, “UOT Electric March II” was turning on the slippery test road, so-called skid pad (Fig. 11). At first, it was making steady turning in the clockwise direction. Turning radius and chassis velocity were about 25-30 [m] and 40[km/h], respectively. These values were closed to the unstable region. At 0 [s], acceleration torque of 1000 [N] was applied for rear two motors. Without any feedback control, this excessive acceleration causes the unstable vehicle motion. Fig. 12 shows this unstable vehicle motion². The rear-right or rear-inside wheel started skidding seriously. Then yaw rate γ unstably grew as shown in the upper-right graph of Fig. 12. It indicates the spin motion. Vehicle was completely out of control and at 2[sec], experiment was terminated for safety reasons.

On the contrary, such dangerous motion could be prevented with minor feedback of wheel velocity. Fig. 13 and Fig. 14 shows this effect clearly. Note that controllers on rear-left and rear-right wheels are the same and independent ones. Each controller only requires the value of each wheel’s velocity, thus it is not “connected” with each other in any meanings. Consequently, it can be said that autonomous stabilization of each driven wheel was achieved, and it enhanced the vehicle lateral stability. This indicates the validity of simulations in the previous section.

One of the remaining problems is the high-frequency oscillation induced at the rear wheels. We suppose that it depends on the design of controller. The cut-off frequency τ in the proposed controller (Fig. 5) may have the important influence on this oscillation, however, such discussions must wait for the next experiments.

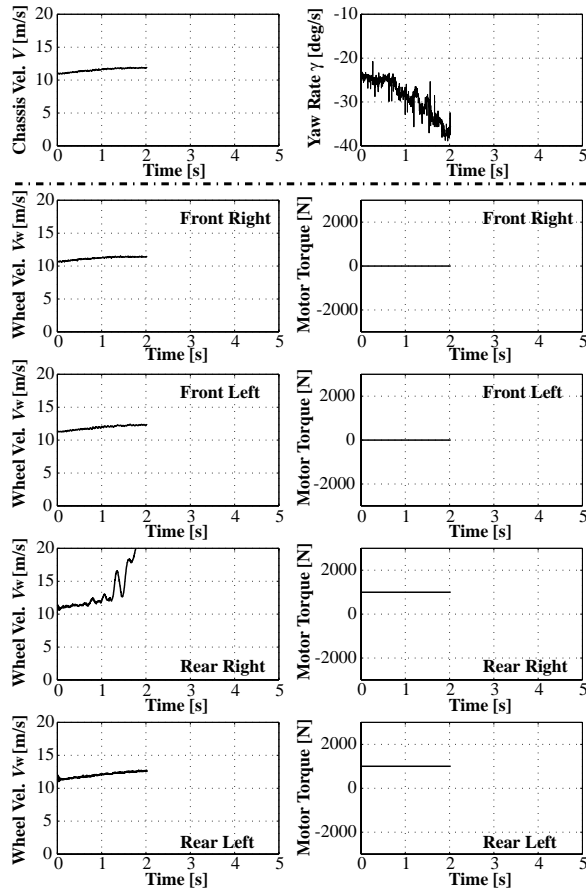

Fig. 12: Unstable turning with sudden acceleration torque on rear wheels. Vehicle made steady turning before torque inputs.

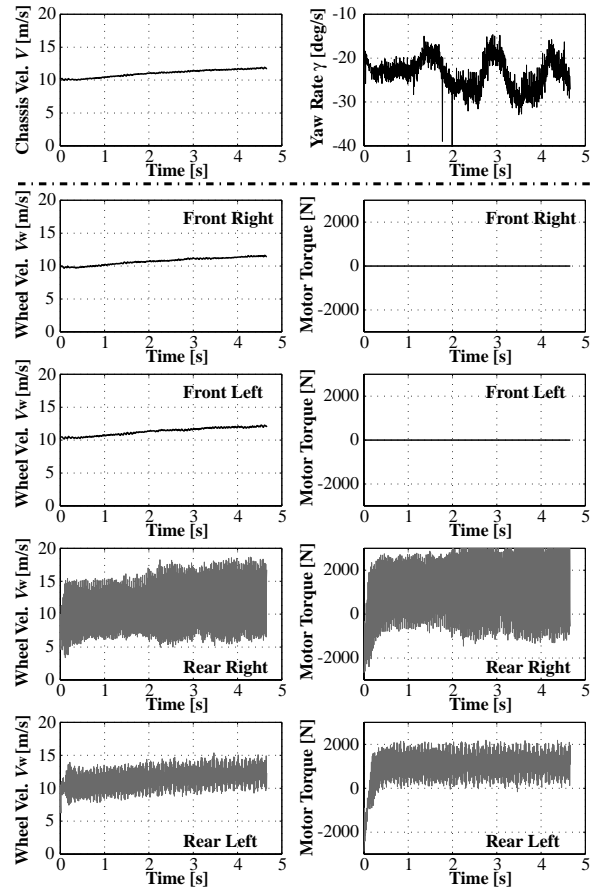

Fig. 13: Stabilizing effect of wheel velocity feedback. Proposed controller of Fig. [?] was applied on both rear wheels.

²Chassis velocities in Figs. 12 and 13 are the mean values of trailing front wheels.

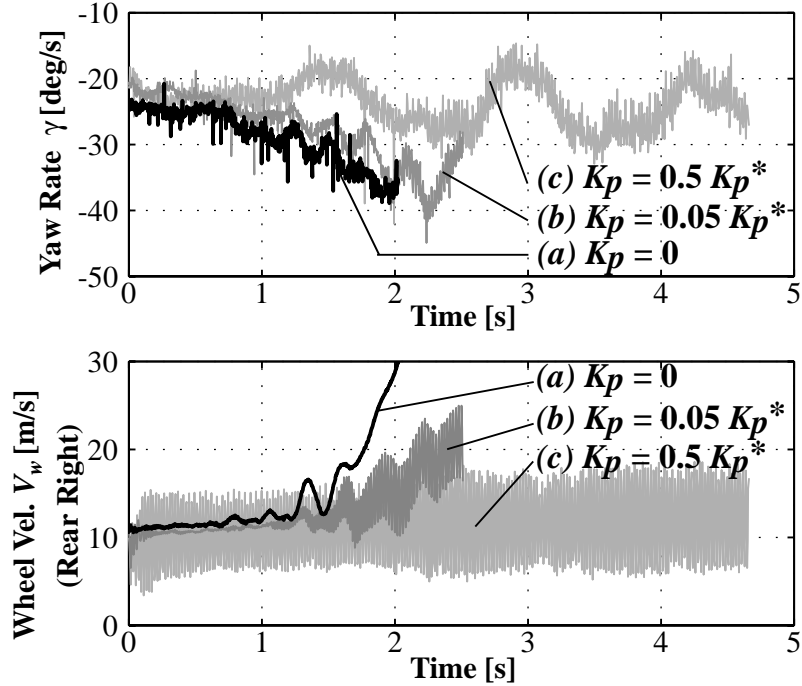

Fig. 14: Comparison of vehicle motion: (a) without feedback controller, (b) with weak feedback controller, (c) and adequate feedback controller. K_p^* of Eq. (16) is 45.2 for this vehicle. τ in the controller was 0.1 [s].

5 Conclusion

In this paper, we discussed on the advantage of EVs in motion control issue. The goal is to enhance the vehicle stability with feedback control of motors. We proposed the wheel velocity feedback for skid prevention. It is a fast linear feedback loop, thus it can utilize the advantage of EVs: the fast torque response. This controller can change the wheel's dynamics, or increases the equivalent inertia of wheel. We assume that these independently-controlled wheels can enhance the vehicle's lateral stability, as we showed with simulations. It is also demonstrated with actual 4-motored EV, "UOT Electric March II". In the latter part of this paper, we introduced this new EV and reported its first experimental results. These results suggests that the fast minor feedback approach can stabilize the vehicle's lateral dynamics.

Active control of lateral motion is also researched in automobile engineering. Most of conventional approaches based on the β estimation and its stabilization [9]. Chassis slip angle β is an important state value, since it indicates the stability of lateral motion. However, β cannot be easily measured or estimated. Our approach is feedback-based approach and currently not using β value. This indicates the possibility of lateral motion stabilization without accurate β estimation. If stability is maintained with this approach, lateral controller will afford the improvement of lateral response. If vehicle's response from steering input to the yaw rate γ is linearized, it comes to be more easy and safe for us to steer the vehicle.

One of the remaining studies is the further discussions with intensive experiments using our new EV. Note that this paper just reports the first experimental results. Consecutive experiments have been programmed already. Another works to do are the theoretical studies. For example, the relationship between the driven wheel's minor loop and whole stability of chassis is not clarified enough yet. Our final goal is the integrated system of total chassis control system like DYC, which has the minor feedback loop. Fig. 15 depicts our idea typically. Such fast minor feedback approach is difficult with slow actuator like engine or hydraulic brake. Therefore, it is appropriate for EVs, HEVs and FCEVs, which are the prospective major vehicles in the next decade.

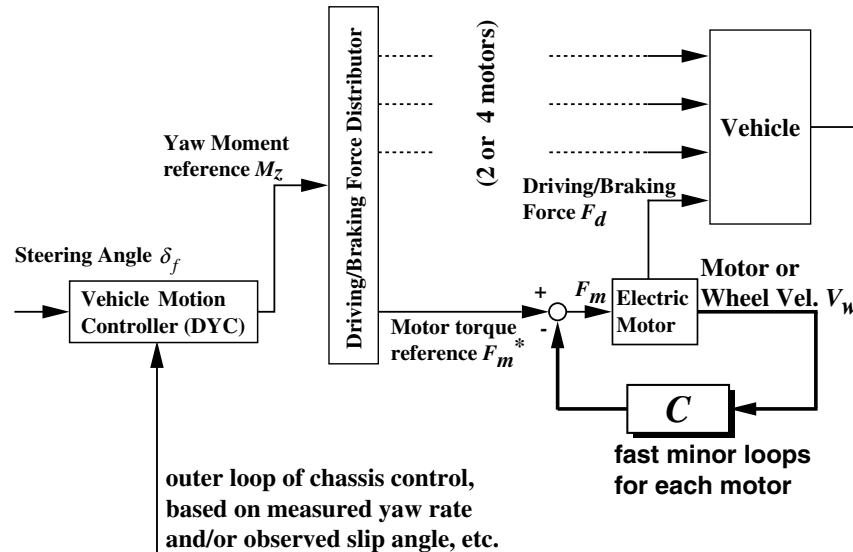

Fig. 15: Our idea for total system: chassis controller with fast minor loops.

References

- [1] Y. Hori, Y. Toyoda, and Y. Tsuruoka. Traction control of electric vehicle: Basic experimental results using the test EV “UOT Electric March”. *IEEE Trans. Ind. Applicat.*, Vol. 34, No. 5, pp. 1131–1138, 1998.
- [2] Hideo Sado, Shin-ichiro Sakai, and Yoichi Hori. Road condition estimation for traction control in electric vehicle. In *The 1999 IEEE International Symposium on Industrial Electronics*, pp. 973–978, Bled, Slovenia, 1999.
- [3] Shin-ichiro Sakai, Hideo Sado, and Yoichi Hori. Novel skid avoidance method without vehicle chassis speed for electric vehicle. In *Proc. International Power Electronics Conference (IPEC)*, Vol. 4, pp. 1979–1984, Tokyo, Japan, 2000.
- [4] Yasuji Shibahata, et al. The improvement of vehicle maneuverability by direct yaw moment control. In *Proc. AVEC '92*, No. 923081, 1992.
- [5] Sumio Motoyama, et al. Effect of traction force distribution control on vehicle dynamics. In *Proc. AVEC '92*, No. 923080, 1992.
- [6] Shin-ichiro Sakai and Yoichi Hori. Advanced vehicle motion control of electric vehicle based on the fast motor torque response. In *Proc. 5th International Symposium on Advanced Vehicle Control (AVEC)*, pp. 729–736, Michigan, USA, 2000.
- [7] Shin-ichiro Sakai, Hideo Sado, and Yoichi Hori. Motion control in an electric vehicle with 4 independently driven in-wheel motors. *IEEE Trans. on Mechatronics*, Vol. 4, No. 1, pp. 9–16, 1999.
- [8] Y. Furukawa and M. Abe. Direct yaw moment control with estimating side-slip angle by using on-board-tire-model. In *Proc. 4th International Symposium on Advanced Vehicle Control*, pp. 431–436, Nagoya, 1998.
- [9] Masato Abe, Yoshio Kano, and Kazuasa Suzuki. An experimental validation of side-slip control to compensate vehicle lateral dynamics for a loss of stability due to nonlinear tire characteristics. In *Proc. AVEC 2000*, pp. 179–186, 2000.