

Advantage of Electric Motor for Anti Skid Control of Electric Vehicle

Shin-ichiro* Sakai and Yoichi Hori**

* The Institute of Space and Astronautical Science

3-3-1 Yoshinodai, Sagamihara, Kawasaki, Kanagawa 229-8510, Japan.

URL: www.hori.t.u-tokyo.ac.jp/997/sakai

E-mail: sakai@pub.isas.ac.jp

** Department of Electrical Engineering, The University of Tokyo

7-3-1 Hongo, Bunkyo, Tokyo, 113-8656, Japan.

E-mail: hori@hori.t.u-tokyo.ac.jp

Abstract.

Electric vehicles (EVs) are driven by motors, which is an excellent actuator for motion control compared to combustion engines or hydraulic braking systems. One principal advantage of motor is its fast and precise torque response. Thus, the fast feedback control can be applied in EVs. In this paper, such fast feedback control with motor is applied for anti skid control. Some experimental results show the anti skid effect of motor feedback controller, which attempts to increase the equivalent wheel inertia. Then the influence of actuator's response delay is evaluated, resulting that such feedback control is difficult with slow actuator like hydraulic braking system. These discussions indicate the advantages of motor, however, the actual braking systems in most EVs and hybrid EVs (HEVs) are not pure electric ones at this moment. Therefore, regenerative braking control cooperating with hydraulic braking is also proposed and discussed. It reduces the braking distance by 20% in the simulations.

Keywords: Electric vehicles, Hybrid vehicles, Antilock braking system(ABS), Vehicle dynamics, Motion control.

1. INTRODUCTION

Recently, electric vehicles (EVs) have attracted great interests as a powerful solution against environmental and energy problems. With improvement of motors and batteries, some pure EV (PEV) with only secondary batteries have already achieved enough performance. Hybrid EV (HEV), like Toyota Prius, is going up to the commercial products. Fuel cell EV (FCEV) will possibly be a major vehicle in the 21st century.

From the viewpoint of electric and control engineering, EVs have evident advantages over conventional internal combustion engine vehicles(ICV). One of them is the fast and precise torque response of electric motor. Output torque of motors can be controlled in much shorter control period and much more precisely, than internal combustion engines or hydraulic braking systems. Thus more effective antilock braking system (ABS) or traction control system (TCS) should be available in EVs.

In this paper, we compare the electric motor with hydraulic braking, as an actuator of ABS. With simulations considering the delay in the actuator response, the advantage of electric motor, fast torque response, is clarified. Wheel velocity feedback control is applied for these simulations, which is examined with our experimental EV. We also discuss on how to cooperate such motor control with hydraulic braking system.

2. HYDRAULIC AND ELECTRIC BRAKING

In the conventional ICV, hydraulic braking system is generally used. The brake torque on each wheel depends on the hydraulic pressure of wheel brake cylinder. To control the hydraulic pressure, some solenoid valves are used. Each solenoid valve can change the connection of hydraulic circuitry, to control the hydraulic pressure.

In the hydraulic ABS, delay in the response of braking torque is considerable. One source of this delay is the dead time of the solenoid valve. It is said to be more than some mili-seconds, for example 10 [ms] [1]. Another reason of the response delay is in the hydraulic circuitry, which connects solenoid valves and the wheel brake cylinder. In results, the transfer function from the commanded braking torque to the actual torque may be expressed with dead time of 10-40[ms] and first order delay system with 50-100[ms] time constant.

On the other hand, regenerative braking is widely applied for recent EVs. In such EV, electric motor can be an actuator of ABS without any additional components. The time response of the electric motor is quite fast, such as 1[ms].

In the following part of this paper, the influence of such delay in the ABS system will be discussed, with brake actuator model such as

$$G(s) = e^{-\tau_D} \frac{1}{\tau_m s + 1}, \quad (1)$$

with 5 types of parameters, as shown in Tab. 1.

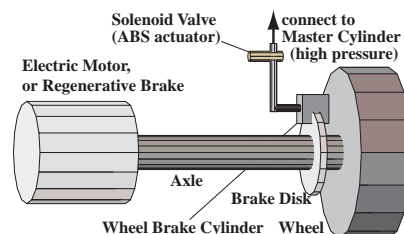

Fig. 1. Hydraulic and regenerative braking.

		τ_D	τ_m
Type-I	(electric motor)	100 [μ s]	1 [ms]
Type-II	(hydraulic brake)	5 [ms]	50 [ms]
Type-III	(hydraulic brake)	10 [ms]	50 [ms]
Type-IV	(hydraulic brake)	20 [ms]	100 [ms]
Type-V	(hydraulic brake)	30 [ms]	100 [ms]

Tab. 1. Braking torque response models for the simulations

3. SLIP PHENOMENA AND ANTI SKID CONTROL METHODS

To discuss about the influence of delay in ABS systems, here authors mention about the slip phenomena of wheel. Ordinary, slip ratio λ is used to evaluate the “slip”. For decelerating wheel, slip ratio λ is defined as,

$$\lambda = \frac{V_w - V}{V}, \quad (2)$$

where V is the vehicle chassis velocity. V_w is the velocity equivalent value of wheel velocity, $V_w = r\omega$, where r , ω are the wheel radius and wheel rotating velocity, respectively.

With simple one wheel model (Fig.2), the motion equations of wheel and chassis can be obtained as

$$M_w \frac{dV_w}{dt} = F_m - F_d(\lambda) \quad (3)$$

$$M \frac{dV}{dt} = F_d(\lambda) \quad (4)$$

if air resistance on chassis and rotating resistance on wheel are both negligible. M and M_w are the vehicle weight and the mass equivalent value of wheel inertia, respectively. F_m is the force equivalent value of accelerating/decelerating torque, generated by engine, hydraulic brake system or motor. F_d is the driving/braking force between the wheel and the road. This F_d has nonlinear dependence on the slip ratio λ . Here normalized traction force μ is defined as

$$\mu = \frac{F_d}{N}, \quad (5)$$

where N is the normal force on the wheel. Fig. 3 plots this normalized traction force μ vs. slip ratio.

If large torque rapidly generated on the wheel, or the F_d suddenly drops with changing road condition, then wheel skid occurs. Once skid occurs, slip ratio λ rapidly increases toward 1.0. With such large slip ratio, the driving/braking force F_d decreases as shown in Fig. 3. More serious problem is that, the side force generation on wheel rapidly disappears with increasing slip ratio. This causes unstable vehicle lateral motion, such as dangerous spin motion.

Therefore, ABS was proposed and is widely used. Various method has been proposed for ABS [2]. Most conventional systems sense the acceleration of wheel velocity and/or slip ratio, and control the wheel brake cylinder's hydraulic pressure. Fig. 4 is an example of ABS response. This graph shows a concept of enhanced ABS with statistical analysis, however, large drop of wheel velocity appears at the beginning of control [3].

In the following part of this paper, we discuss about the ABS controller for electric vehicle. However, our experimental vehicle has a series-wound DC motor and an one-quadrant chopper. It means that the electric brake is impossible with our vehicle. Therefore, in the following sections, we will study about the skid prevention for accelerating vehicle, like skid prevention with TCS.

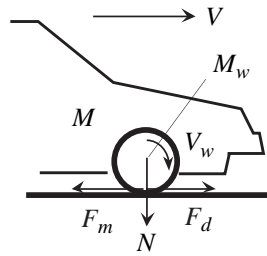

Fig. 2. One wheel model.

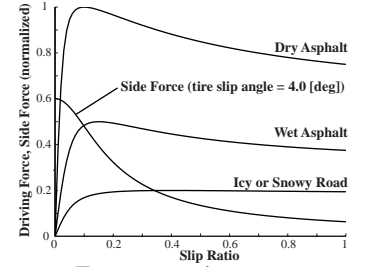

Fig. 3. $\mu - \lambda$ curve.

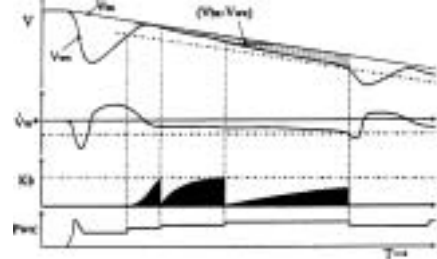

Fig. 4. Time response of chassis velocity V_{bx} and wheel velocity V_{wx} , which depicts the concept of enhanced ABS [3].

4. ANTI SKID EFFECT OF WHEEL VELOCITY CONTROL

As shown in Fig. 4, the wheel velocity drops when the wheel skid occurs with rapid braking torque input. Therefore, the feedback control of wheel velocity seems to be effective, to suppress the sharp increase of slip ratio. Model following control(MFC) of wheel velocity was proposed for this aim [4]. Fig. 5 shows the block diagram of MFC. The sensitivity function can be calculated as

$$S(s) = \frac{s + a}{s + b}, \quad (6)$$

where

$$a = \frac{M + (1 - K_p)M_w}{(M + M_w)\tau}, \quad (7)$$

$$b = \frac{(1 + K_p)M + M_w}{(M + M_w)\tau}. \quad (8)$$

As shown in Fig. 5, K_p and τ are the feedback gain and time constant of MFC. The aim of this control is to suppress the rapid increase of wheel velocity. Note that strict control of wheel velocity is not required, thus the finite gain of $S(s)$ in the low frequency region is allowed.

In [4], MFC was only discussed with brief skid such as for 0.5[sec]. Therefore, additional experiments were carried out in this paper. These experiments were carried out with “UOT Electric March-I”, which is our laboratory-made EV (Fig. 6). To examine the effect of MFC for skid avoidance, slippery low μ road is required. We put the aluminum plates of 14[m] length on the asphalt, and spread water on these plates. The peak μ of this test road is about 0.5. This value was estimated based on some other experimental results.

Fig. 7 shows the time responses of slip ratio. In these experiments, vehicle accelerated on the slippery test road,

with lineally increasing motor torque. Without MFC, the slip ratio rapidly increases. On the contrary, the increase of slip ratio is relatively slow with MFC. Fig. 8 plots the wheel and chassis speed. It shows the wheel velocity's insensitivity to the slip status. In another words, the wheel equivalent inertia during the wheel skidding comes to be "heavy" with MFC, thus the rapid increase of slip ratio can be suppressed. The simulation results almost agrees with the experimental results ¹, indicating the reliability of simulations in the following sections.

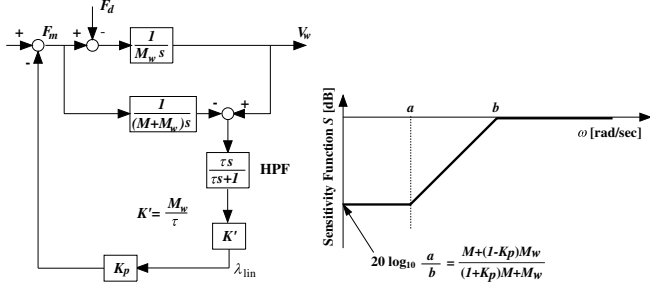

Fig. 5. Block Diagram of MFC (left fig.), and Sensitivity function $S(s)$ of MFC (right fig.).

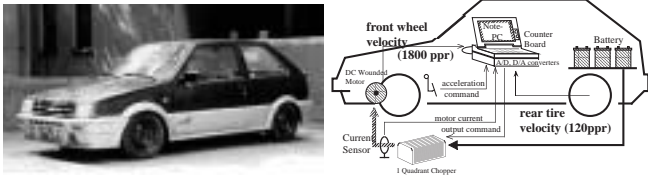

Fig. 6. Our experimental vehicle, "UOT Electric March-I".

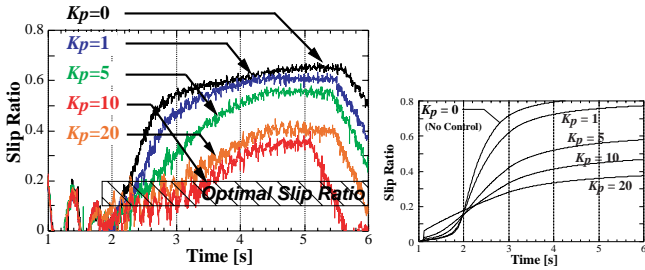

Fig. 7. MFC effect for skid prevention with $\tau=0.1[s]$ (Left fig.: Experimental results / Right fig.: Simulation results)

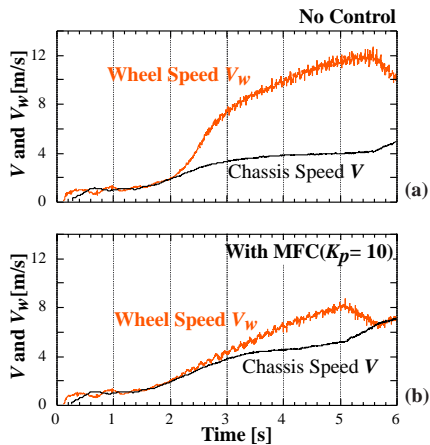

Fig. 8. Wheel and chassis velocity with and without MFC.

¹The motor current was saturated in the experiments, with high V_w . At about 5.5[s], the EV reached at the end of the slippery test road and run again on the dry asphalt. These are the reason of the difference between experimental and simulation results.

5. INFLUENCE OF ACTUATOR'S RESPONSE DELAY ON THE WHEEL VELOCITY CONTROL

Wheel velocity feedback control was discussed in the previous section. Is it possible to do the same thing with hydraulic braking system? To discuss this issue, the influence of actuator's response delay in wheel velocity control is evaluated in this section.

5.1. Design of wheel velocity controller

The response delay seems to limit the feedback controller gain. To change the controller gain depending on the response delay, here we directly design the sensitivity function $S(s)$. This design process is based on the two-degree-of-freedom controller design method [5]. Fig. 9 depicts the structure of two-degree-of-freedom controller [5]. Here, u is the controller's output, r is the reference value, y is the output of plant, d is the disturbance and ξ is the observation noise. In this method, controller is determined with the design of command input response $G_{yr}(s)$ and sensitivity function $S(s)$. With $G_{yr}(s)$ and $S(s)$, the feedforward controller $C_1(s)$ and feedback controller $C_2(s)$ can be obtained as:

$$C_1(s) = \frac{G_{yr}(s)}{P_n(s)S(s)} \quad (9)$$

$$C_2(s) = \frac{1 - S(s)}{P_n(s)S(s)} \quad (10)$$

where P_n is the nominal plant model. Here this controller is for skid prevention, thus the nominal plant model should be the model of adhesive wheel, such as

$$P_n(s) = \frac{1}{M + M_w} \quad (11)$$

As commonly known, the sensitivity function $S(s)$ determine the disturbance rejection performance. In general case, $S(s)$ should have low gain in the low-frequency domain to suppress the disturbance or plant parameter fluctuation. One the contrary, $1 - S(s)$, so called complementary sensitivity function, should be a low-pass filter, to make the system robust for the high frequency observation noise. At the same time, $S(s)$ or $1 - S(s)$ must satisfy some other conditions [5].

In this paper, $S(s)$ is selected as

$$S(s) = \frac{s^2}{(s + w_c)^2} \quad (12)$$

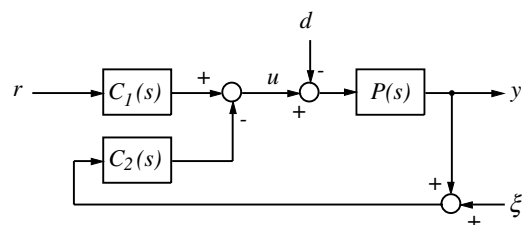

Fig. 9. Two-degree-of-freedom control system.

Therefore, the parameter of controller is only w_c . Large w_c causes the high cut-off frequency of sensitivity function $S(s)$, and this indicates the strong disturbance rejection and weak robustness for plant modeling error. In other words, high w_c means the high gain feedback controller.

$G_{yr}(s)$ is set to be

$$G_{yr}(s) = \frac{1}{\tau_{yr}s + 1}, \quad (13)$$

however, command response is not important in this paper. Thus the τ_{yr} is always 0.5[s] in this paper.

5.2. Simulations with delay in the response

Then some simulations are carried out for skid prevention. In these simulations, nonlinear normalized traction force $\mu(s) = F_d/N$ is calculated with approximated equation, so-called Magic Formula [6]. Parameters in Magic Formula are selected for $\mu - \lambda$ curve to have its peak value μ_{peak} at $\lambda = 0.1$. At 1.0[s], the driver or controller starts to input accelerating torque. This torque causes the wheel velocity increasing rate of $dV_w/dt = 2[\text{m/s}^2]$. The road condition is almost adhesive ($\mu_{\text{peak}} = 0.75$) at the beginning of this simulation, and at 3.0[s], suddenly changes into slippery condition ($\mu_{\text{peak}} = 0.4$).

Without feedback control, serious wheel skid occurs at 3.0[s] as shown in Fig. 10. On the contrary, such rapid increase of slip ratio can be suppressed if high-gain wheel velocity controller is applied (Fig. 11).

However, if non-negligible response delay exists in the actuator, high w_c such as 500[rad/sec] make the system unstable. Therefore, the appropriate w_c must be chosen for each type of actuator. In this paper we find out the highest value of w_c for each actuator as following:

1. We select high w_c at first, such as 500[rad/sec].
2. Then carry out the simulation, and if it is not stable, decrease w_c as $w_c[i + 1] = 0.9 w_c[i]$.
3. Finally the simulation comes to be stable, then w_c at that simulation should be the highest one for that type of actuator.

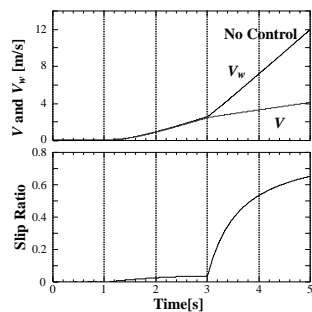

Fig. 10. Simulation results without control.

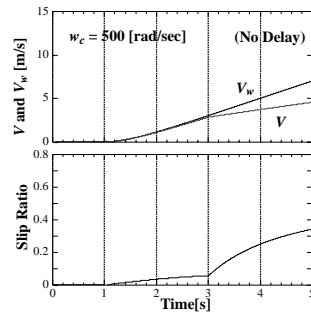

Fig. 11. Simulation results with high-gain controller.

In the following simulations, each w_c is set to be the half value of its “highest” value.

Fig. 12 shows the simulation results with various actuators from Type-I to Type-V. Dead time and delay time are not negligible, therefore, high cut-off frequency w_c could not be selected. The limitation of w_c comes to be more strict, when the delay becomes to be larger. With such low w_c the disturbance or plant fluctuation can not be fully rejected. In these simulation, the wheel velocity is affected by: (1) drop of traction force F_d , i.e., disturbance, (2) and the plant fluctuation. Note that once skid occurs, the plant changes from nominal model $1/(M + M_w)$ to $1/M_w$. Therefore, the wheel velocity is disturbed when the road condition changes at 3.0[s], as shown in Fig. 12.

With these simulations, we can point out that w_c should be more than 5 [rad/sec] to suppress the sharp increase of slip ratio. To apply such high w_c , dead time should be less than 5~10[ms]. It is not so easy for hydraulic brake system. Therefore, it seems that the rapid change of wheel velocity cannot be suppressed with feedback control in conventional ABS, as shown in Fig. 4. The other method is some control algorithm like feedforward control, however, this requires a little time for road condition estimation. Thus the first drop of wheel velocity cannot be prevented.

On the contrary, the dead time of electric motor can easily be less than 1[ms]. Accordingly, the cut-off frequency of sensitivity function or the feedback gain can be high enough. This is the principal advantage of electric motor in ABS or TCS systems.

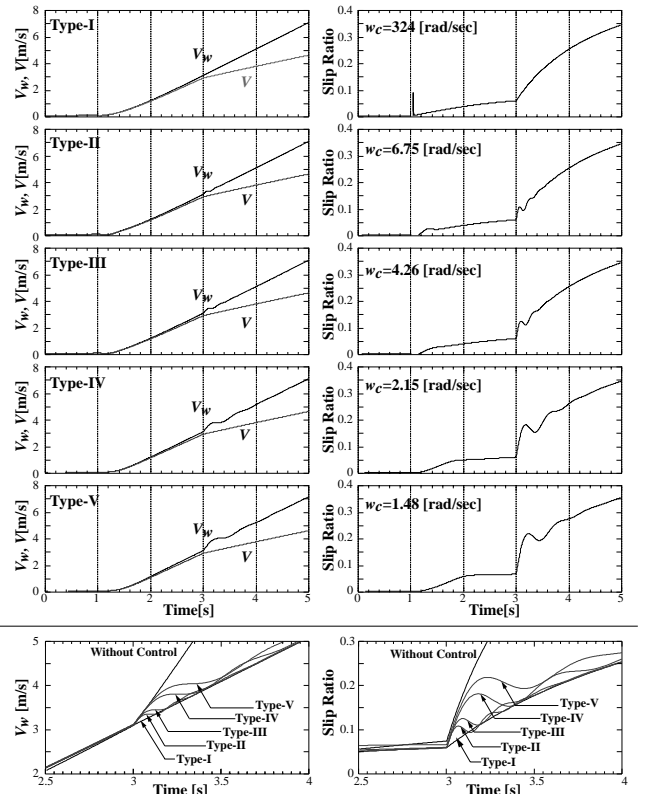

Fig. 12. Simulation results with Type-I,II,III,IV and V actuators.

6. REGENERATIVE BRAKING CONTROL FOR SKID PREVENTION COOPERATING WITH HYDRAULIC ABS

With motor or regenerative braking, fast feedback control can be applied as mentioned above. Such controller can change the dynamics of wheel, for example, change the wheel's equivalent inertia to be quite heavy.

In this section, regenerative braking control cooperating with hydraulic ABS is introduced. In most EVs or HEVs, regenerative braking is generally used with hydraulic braking system. Pure electric braking is not applied at this moment. The reason is the maximum torque limitation of motor, batteries' SOC (state of charge), or expectation for the reliability of mechanical systems. Thus if someone attempt to apply the anti skid method with motor control, cooperation or interference between regenerative and hydraulic braking must be considered. Here we show some idea to do such control.

6.1. Regenerative braking controller design

The controller design's strategy is quite similar to MFC, described above. One of the problems of hydraulic ABS is the delay in the skid detection or actuator response. Thus here we aim to compensate the wheel's short-time dynamics within such delay time.

Fig. 13 shows the block diagram of proposed controller. We apply some minor feedback loop with motor. This feedback controller can be described with $P_n(s)$ and $Q(s)$, such as,

$$\begin{aligned} P_n(s) &= \frac{1}{(M + M_w)s}, \\ Q(s) &= Ms \frac{1}{\tau s + 1}. \end{aligned} \quad (14)$$

Here we denote the braking torque with F_{brake} , which is

$$F_{\text{brake}} = F_{\text{motor}} + F_{\text{ABS}}, \quad (15)$$

where F_{motor} and F_{ABS} is the regenerative and hydraulic braking torque, respectively. With feedback controller of (14) and $\tau=0.1[\text{s}]$, the transfer function $H(s)$ from F_{ABS} to F_{brake} can be changed as Fig. 14. Fig. 15 plots $H(s)P(s)$, which is the transfer function from F_{ABS} to V_w . These bode diagrams are calculated with simple wheel model as,

$$P(s) = \begin{cases} P_{\text{adh}}(s) = \frac{1}{(M + M_w)s} & : \text{for adhesive wheel,} \\ P_{\text{skid}}(s) = \frac{1}{M_w s} & : \text{for skidding wheel.} \end{cases} \quad (16)$$

The remaining problem of this controller is the steady-state gain for adhesive wheel, $H(0)_{\text{adh}}$,

$$H(0)_{\text{adh}} = \frac{M + M_w}{2M + M_w} \neq 1.0. \quad (17)$$

Eq. (17) means that the transmission of hydraulic braking torque is blocked with motor torque. To prevent this

blocking, the feedforward controller C_{FF} is designed as,

$$C_{\text{FF}}(s) = 1 - H_{\text{adh}}(0) = \frac{M}{2M + M_w}. \quad (18)$$

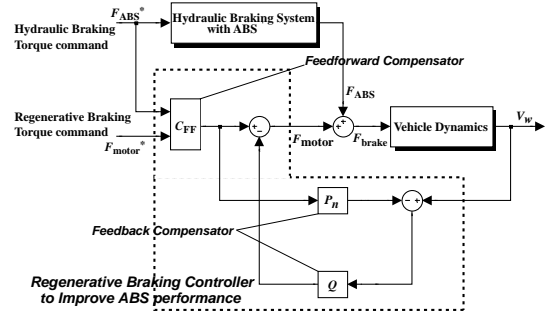

Fig. 13. Block diagram of proposed controller.

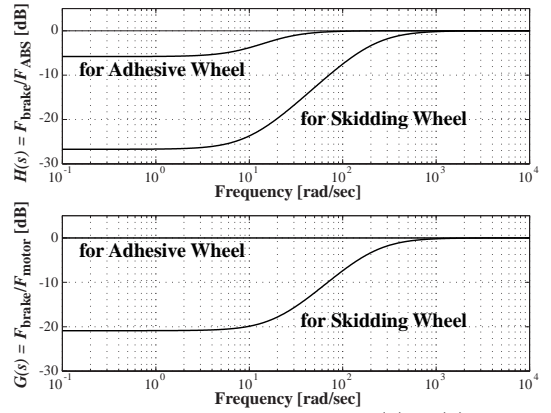

Fig. 14. Bode diagram of $H(s), G(s)$.

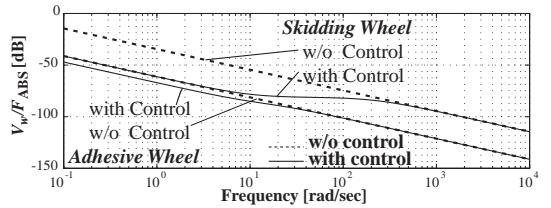

Fig. 15. Bode diagram of $H(s)P(s)$.

6.2. Simulation results

Simulations are carried out to confirm the effectiveness of proposed controller. These simulations are with one wheel vehicle model (Fig. 2) and nonlinear Magic Formula tire model. Tab. 2 shows the parameters. ABS controller is modeled simply as bang-bang controller, with time delay in Tab. 2.

Fig. 16 shows the simulation results with adhesive road condition ($\mu_{\text{peak}} = 1.0$). The motor generates the commanded regenerative braking torque, which is required by upper layer controller, for example to maximize the energy efficiency. The feedback controller does not block or interfere with the hydraulic braking torque.

Fig. 17 shows the results with slippery road condition ($\mu_{\text{peak}} = 0.5$). The left column shows the results with only hydraulic ABS, and the right column shows the results with hydraulic ABS and proposed controller. Fig. 17 shows that the slip ratio oscillation can be suppressed with proposed regenerative brake controller. The braking force is enlarged by this effect, therefore, the braking distance can be reduced by 20 %.

Vehicle weight (M)	1100[kg]
Wheel inertia (M_w)	53.3[kg]
Dead time in skid detection (τ_{Ds})	50[ms]
Dead time in ABS torque response (τ_D)	20[ms]
1 st order Delay in ABS torque response (τ_m)	50[ms]
Max. of Hydraulic Braking torque	4000[N]
Max. of Regenerative Braking torque	2000[N]
1 st order Delay in Motor torque response	1[ms]

Tab. 2. Parameters in the simulations.

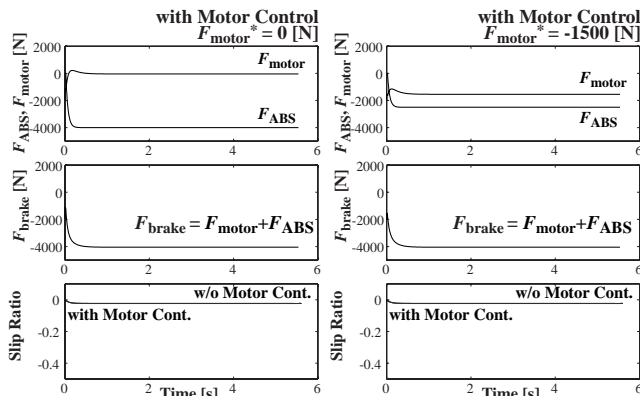

Fig. 16. Simulation results with adhesive road.

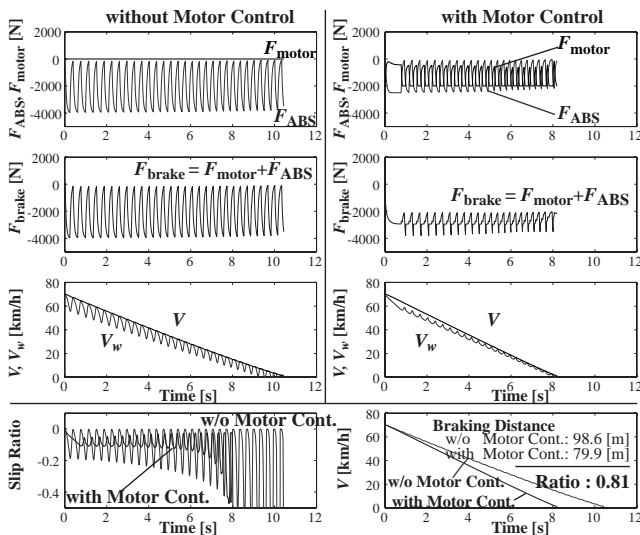

Fig. 17. Simulation results with slippery road. ($F_{motor}^* = -1500$ [N])

7. CONCLUSION

In this paper, the electric motor was compared with hydraulic braking system, as an actuator of ABS. Experimental results showed that the wheel velocity control, such as MFC, is effective to change the wheel dynamics and suppress the rapid wheel skid. Simulation results pointed out that such feedback control requires fast torque response. If the actuator is slow as hydraulic braking, then the feedback gain could not be high enough to prevent the rapid change of wheel velocity. Therefore, more effective ABS will be available essentially.

These wheel velocity controller can prevent the sudden change of wheel velocity, however, there remains another problem. Even the wheel velocity is controlled, slip ratio will increase on the slippery road, with the change of chassis velocity. Experimental results in Fig. 7 show it clearly. Therefore, such method should be combined with another method like conventional ABS or skid detection method without chassis velocity[7]. Moreover, in most EVs or HEVs, regenerative braking is used with hydraulic braking. Thus the cooperation should be considered for practical use. With these backgrounds, in the latter part of this paper, regenerative braking control method cooperating hydraulic ABS was proposed. This method changes the dynamics of wheel with minor loop control of regenerative braking torque, and could reduce the braking distance by 20% in the simulations. This proposed method shows an practical example of “utilization of motion control technique in EVs”.



Shin-ichiro Sakai: He received the B.S., M.S. and Ph.D. degrees in electrical engineering from the University of Tokyo, in 1995, 1997 and 2000, respectively. In 2000 he worked as JSPS Research Fellow in the University of Tokyo, and in 2001 he joined The Institute of Space and Astronautical Science as a research associate. His research fields are control theory and its industrial applications, typically, motion control in electric vehicles, control of satellite in space, mechatronics, etc.



Yoichi Hori: He received the Ph.D. degrees in electrical engineering from the University of Tokyo in 1983. He joined the Dept. of Elec. Eng. at the Univ. of Tokyo as a research associate in 1983. Since 2000, he has been a professor. His research fields are control theory and its industrial application, in particular, motion control, mechatronics, robotics, power electronics, power systems, etc.

References

- [1] Tabe, T., Ohka, N., Kuraoka, H., and Ohba, M. Automotive antiskid system using modern control theory. In *Proc. IEEE IECON'85*, pp. 390–395, San Francisco, USA, 1985.
- [2] Kawabe, T., Nakazawa, M., Notsu, I., and Watanabe, Y. A sliding mode controller for wheel slip ratio control system. In *Proc. AVEC'96*, pp. 797–804, Aachen, Germany, 1996.
- [3] Imoto, Y., Tsuru, N., Imaeda, M., Watanabe, T., and Masaki, S. High-efficiency brake pressure controls in ABS. In *AVEC '98*, pp. 655–660, Nagoya, Japan, 1998.
- [4] Hori, Y., Toyoda, Y., and Tsuruoka, Y. Traction control of electric vehicle: Basic experimental results using the test EV “UOT electric march”. *IEEE Trans. Ind. Applicat.*, Vol. 34, No. 5, pp. 1131–1138, 1998.
- [5] Fujimoto, Y. and Kawamura, A. Robust servo-system based on two-degree-of-freedom control with sliding mode. *IEEE Trans. Ind. Applicat.*, Vol. 42, No. 3, pp. 272–280, 1995.
- [6] Pecejka, H. B. and Bakker, E. The Magic Formula tyre model. In *Proc. 1st International Colloquium on Tyre Models for Vehicle Dynamics Analysis*, Delft, Netherlands, 1991.
- [7] Sakai, S., Sado, H., and Hori, Y. Novel skid avoidance method for electric vehicle with independently controlled 4 in-wheel motors. In *Proc. The 1999 IEEE International Symposium on Industrial Electronics*, pp. 934–939, Bled, Slovenia, 1999.